

# Agilent 6800 Series AC Power Source/Analyzer

Product Note

**Using the Agilent Technologies 6800 Series  
AC Power Source/Analyzers for Generation  
and Measurement**



#### **Applications:**

- Simulating AC Line Sub-Cycle Dropouts
- Generating MIL-STD-704D Waveforms
- Performing IEC 555-2 Measurements
- Performing Inrush Current Measurements
- Generating User-Defined Waveforms
- Operating the Agilent 6812A and 6813A at Low Frequencies



**Agilent Technologies**  
Innovating the HP Way

## **Introduction**

This note provides information on how you can use the features of the Agilent Technologies 6800 series ac power source/analyzers to address a variety of applications. Although your exact application may not be listed here, the capabilities described can be generalized and applied to your specific needs. The programming examples are given in QBASIC.

These are the capabilities that are discussed and a description of how they can be applied:

## **Table of Contents**

3	Introduction to the Agilent 6800 AC Power Source/Analyzer
4	Agilent 6800 Series Output Transients
6	Agilent 6800 Series Triggering
8	Agilent 6800 Series Measurements
11	Application 1: Simulating AC Line Sub-Cycle Dropouts
14	Application 2: Generating MIL-STD-704D Waveforms
18	Application 3: Performing IEC 555-2 Measurements
21	Application 4: Performing Inrush Current Measurements
24	Application 5: Generating User-Defined Waveforms
28	Application 6: Operating the Agilent 6812A and 6813A at Low Frequencies

# Introduction to the Agilent 6800 AC Power Source/Analyzer

The 6800 series ac power source/analyzers are members of the Agilent Technologies “One-Box” Solution power products family. These products offer an integrated solution for ac power testing applications.

The 6800 series combines the functionality of the following instruments in one box:

- power amplifier
- arbitrary waveform generator
- power analyzer
- harmonic analyzer
- waveform digitizer

The power amplifier and arbitrary waveform generator capabilities produce waveforms with programmable amplitude, frequency, and wave-shape. Each model has pre-programmed sine, square, and clipped sine waveshapes. For added flexibility, twelve user-defined waveforms can be created and stored in non-volatile memory.

Waveforms can be programmed using the 6800 series transient generation system to simulate sophisticated and repeatable ac line disturbances or output sequences.

The power analyzer and harmonic analyzer capabilities provide high precision measurements including:

- rms, dc, ac+dc voltage and current
- peak voltage and current
- real, apparent, and reactive power
- harmonic analysis of voltage and current waveforms providing amplitude and phase up to the 50th harmonic
- total harmonic distortion
- triggered acquisition of digitized voltage and current

The 6800 series can be used in bench or ATE applications. The fully featured front panel and built-in GPIB and RS-232 interfaces allow you to program waveforms, measure parameters, and monitor the status of the ac power source/analyzer.

Each model features a SCPI (Standard Commands for Programmable Instruments) command set. This industry standard command set simplifies test system development by offering command set commonality between all types of instrumentation. Instruments performing the same function use the same self-documenting SCPI instructions. For example, the same commands are used to program a wave-shape on the 6800 series ac power source/analyzers as on a function generator. Because you spend less time learning device commands, you can get your application up and running faster.

The following sections of this product note explain how to optimize your usage of the features of the 6800 series products. At the end of this product note there are practical examples that show how these features can be applied.

# Agilent 6800 Series Output Transients

A programmable output value of the ac power source/analyzer can operate in one of four modes: FIXED, Step, Pulse, or List. The default setting is FIXED mode, where the output will stay “fixed” at the programmed value until another command is sent to change it. The remaining three operating modes constitute the Transient Subsystem. Output transients are used to:

- synchronize output changes with a particular phase of the voltage waveform
- synchronize output changes with trigger signals
- simulate ac line disturbances with precise duration and phase control
- create sequences of output changes

Output transients are triggered actions and will cause the output of the ac power source/analyzer to react in a manner defined by the selected mode.

## What Programmable Functions can be Controlled by the Transient Subsystem?

The 6800 series provides control of many output parameters. Most of these can be programmed as an output transient. The following output parameters are subject to transient control:

- ac output voltage
- dc output voltage (Agilent 6812A and 6813A only)
- frequency
- phase (Agilent 6834A only)
- waveform shape
- ac voltage slew rate
- dc voltage slew rate (6812A and 6813A only)
- frequency slew rate
- peak current limit (6812A and 6813A only)
- rms current limit
- dwell time (List mode only)

Upon receipt of a trigger, an output parameter set to Step, Pulse, or List mode will transition from an immediate level (its initial output setting) to one or more levels (successive output settings). The number of successive output settings is, in part, what differentiates one transient mode from another.

## What is a STEP Transient?

A Step transient generates a single triggered output change (from an immediate output level to ONE successive output level) of one or more of the output parameters subject to transient control. Only output parameters programmed to Step mode will be part of the triggered action. The output will remain at the final output level once the Step transient is complete.

## What is a PULSE Transient?

A Pulse transient generates a triggered output change that returns to its immediate output level after a programmed time period. A Pulse transient can also be programmed to repeat the output change more than once or continuously.

## What is a LIST Transient?

A List transient generates a sequence of output changes. Each output change of the sequence is called a List point. All parameters subject to transient control can be programmed at each List point.

A List can contain up to one hundred points. The list of points can be programmed to execute once or to repeat from one to an infinite number of times.

Agilent’s 6800 series List points can be paced by external triggers. When paced by triggers, the output will remain at a particular List point until a trigger is received. Only then will it proceed to the next programmed point.

List points can also be paced by individual programmable dwell time parameters associated with every point. Only when the dwell time for a particular List point expires will it proceed to the next List point.

Once the List is completed, the output returns to the immediate levels.

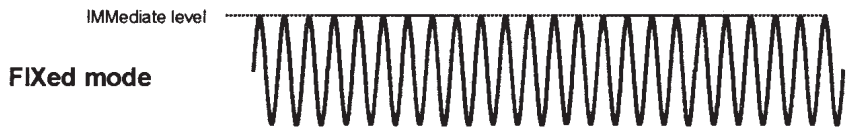

Triggers ignored, output always set to immediate command levels.

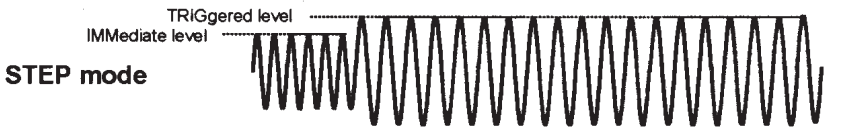

At trigger, the triggered level becomes the new immediate level.

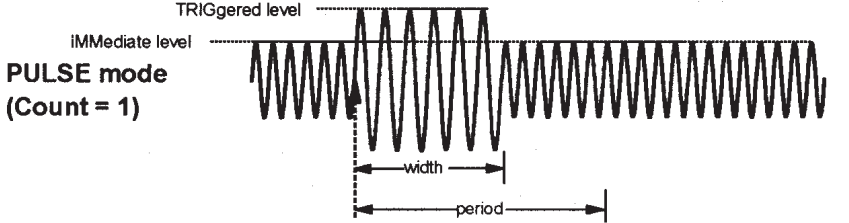

At trigger, the triggered level is active during the pulse width portion of the pulse waveform.

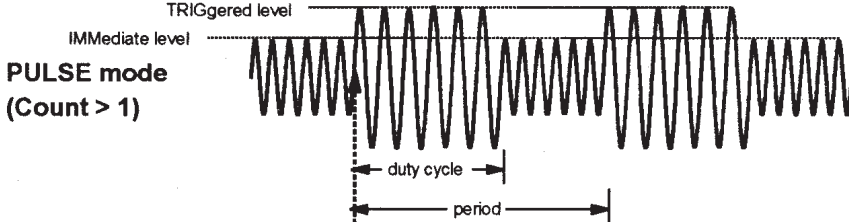

At trigger, the triggered level is active during the duty cycle portion of the pulse waveform.

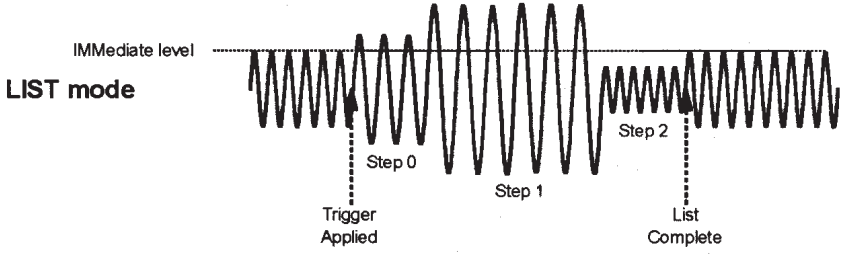

At trigger, the list starts. When list completes, the output returns to immediate level. Steps 0, 1, and 2 can be set to repeat from 1 to infinity upon receipt of trigger.

**Model of the Transient System**

# Agilent 6800 Series Triggering

In ATE applications, triggers are often a convenient way of synchronizing test system events and increasing test throughput. These benefits also apply to the triggering subsystems in the 6800 series products since these products combine the capabilities of many test instruments. Each model is equipped with the ability to send and receive triggers, and to perform or initiate a multitude of synchronized functions upon receiving a trigger.

Triggers can be used to change the output, synchronize a change to a phase of a waveform cycle, and synchronize a measurement to an output change. The effectiveness of the triggering capability can be shown when measuring worst case inrush current of a switching power supply. Using the 6800 series triggering subsystem, the output can be triggered to turn on at a phase near the peak of the ac cycle for simulating a worst case ac line condition. Simultaneously, the ac source can be triggered to take current measurements to characterize the behavior of the power supply under test. In addition, triggering can be extended to external test equipment via the Trigger Out connection.

The 6800 series has two main triggering subsystems, one for generating transients and one for making measurements. These two subsystems have common trigger sources that can synchronize transient and measurement events.

## What Actions Can be Triggered?

The following actions of the 6800 series can be triggered:

- a change in output setting
- the start of a Step, Pulse, or List transient
- the pace of a List sequence
- the acquisition of digitized voltage and current
- the synchronization of an output change to a phase of the cycle

A programmable time delay can be specified for triggers that generate output changes. This allows the insertion of a specified time delay between the receipt of the trigger and the action of the ac power source/analyzer output.

## What Can Serve as the Source of the Trigger?

The 6800 series can receive triggers from the following sources:

**The GPIB.** The computer can send trigger commands to the ac power source/analyzer. There is a short command processing time associated with this source.

**External Trigger In.** This is the 6800 series TRIGGER IN connector. It accepts TTL levels, with the falling edge detected as the trigger.

**TTL Trigger.** The TTL trigger is an internal trigger that causes the acquisition of digitized voltage and current data.

This internal trigger can be generated when an output transient begins or ends, or as the result of List step execution.

## How Can Triggers be Generated?

The 6800 series can generate a trigger on the TRIGGER OUT connector as a result of the following actions:

- the beginning of a Step, Pulse, or List output transient
- the completion of a Step or Pulse output transient
- the completion of a List sequence
- the beginning of a List step

The TRIGGER OUT signal is a nominal 10-microsecond low-true pulse.

## How Can the Agilent 6800 Series be Enabled to Respond to a Trigger?

The default state of the ac power source/analyzer is the idle state where trigger detection is disabled. To respond to a trigger, it must be placed in the "initiated state." This can be done via the front panel or over the bus. Once initiated, the ac power source/analyzer can detect a trigger from the selected source.

When the trigger is detected, the ac power source/analyzer will perform the trigger action after waiting any programmed trigger delay time. Upon completion of the trigger action, the ac power source/analyzer will return to the idle state.

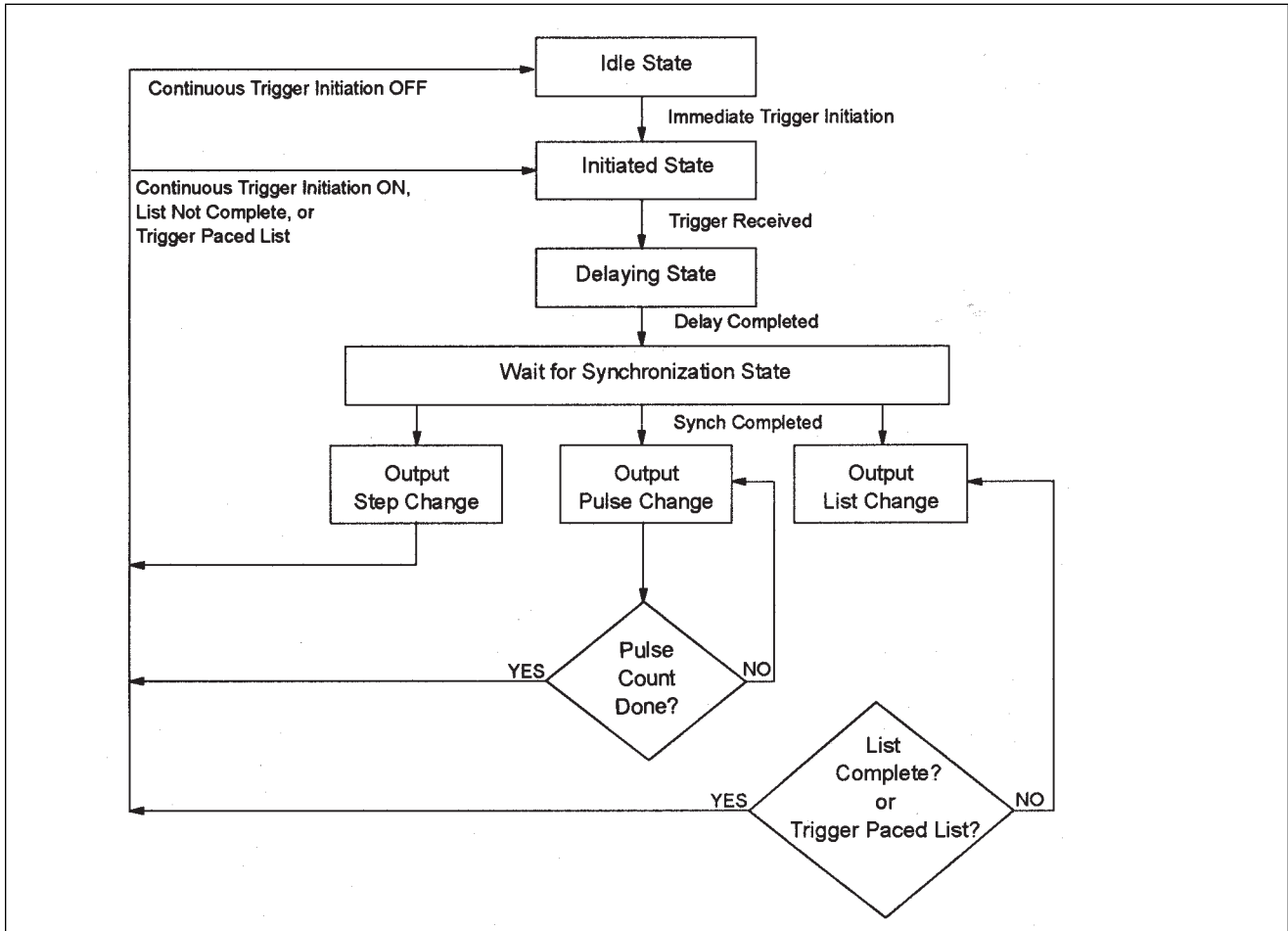

**Output Transient Trigger Model**

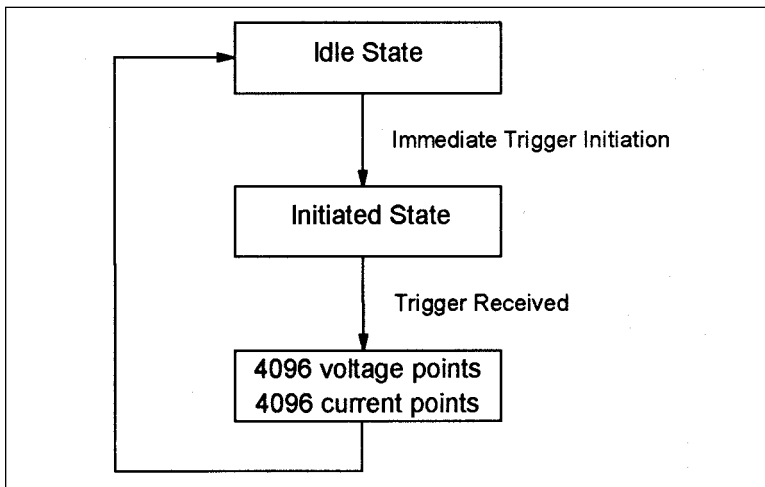

**Measurement Trigger Model**

# Agilent 6800 Series Measurements

The built-in power analyzer capability offers many voltage, current, and power measurements to the user. While on, the ac power source/analyzers are continuously sampling instantaneous output voltage and current for several output cycles and writing the data to buffers. Each buffer, one for voltage and one for current, holds 4096 data points. The voltage and current data is used to calculate the requested measurement parameter. There are two basic methods to obtain a measurement: using the MEASure command or the FETCh command. These commands can return a single measured parameter, an array of voltage and current harmonic data, or an array of the 4096 voltage or current data values.

## What is a MEASure Command?

When this command is sent to the 6800 series ac power source/analyzer, the unit begins acquiring new voltage and current data into its data buffers. Upon completing the acquisition of 4096 data points for voltage and current, the unit then

performs the required calculation to return the requested measurement parameter. When a new acquisition of instantaneous output voltage and current data is desired, this command should be used to return the requested measurement.

## What is a FETCh Command?

This command allows the user to retrieve measured parameters from previously acquired voltage and current data. For example, the FETCh command can be used after a MEASure command to return calculated parameters from the same 4096 data points that were acquired by the MEASure command. In addition, the FETCh command can be used to retrieve measurement information after triggering an acquisition of digitized voltage and current data. This method provides the flexibility to synchronize the data acquisition with a triggered event, and then return many calculations from the existing voltage and current data buffers.

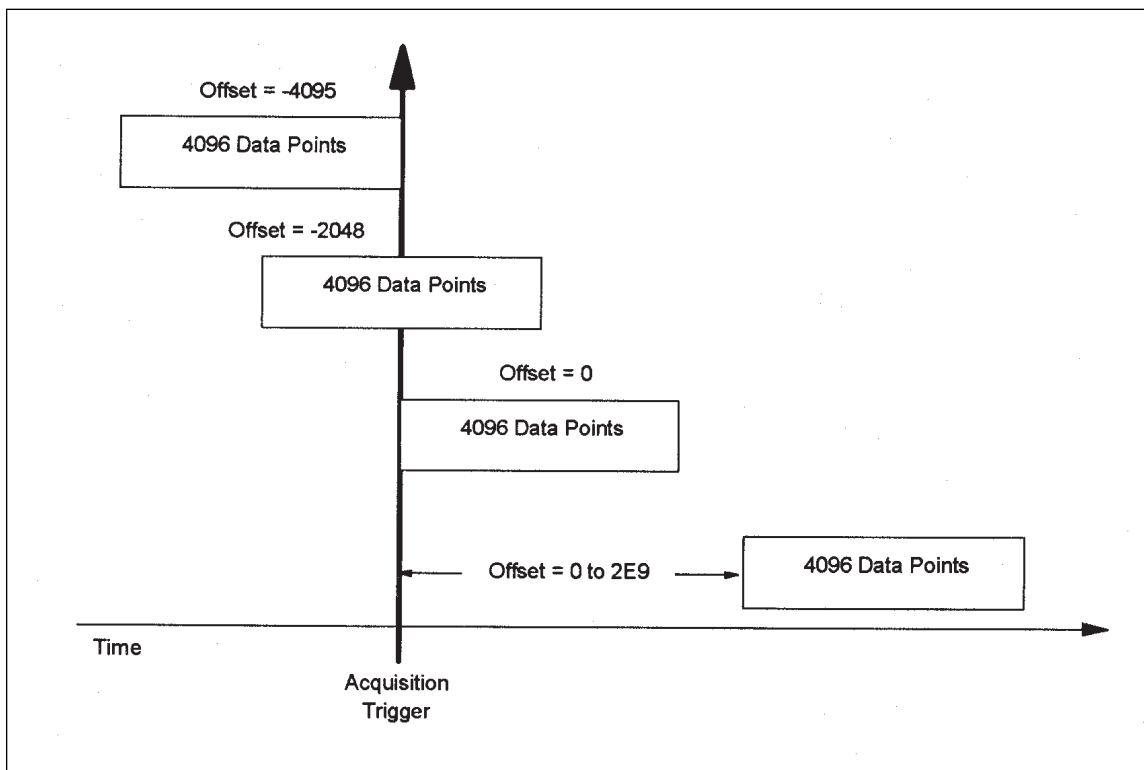

Pre-event and Post-event Acquisition Triggering



## How Can the Acquisition of Voltage and Current Data be Controlled?

Two characteristics of the voltage and current acquisition can be controlled: the sample rate, and the beginning of acquisition relative to the trigger. The ac power source/analyzer has a sample rate of approximately 40 kHz (a sample every 25 microseconds) as the default setting. This means it takes approximately 100 milliseconds for the data buffers to fill with voltage and current data points. The sample period can be programmed from a minimum of 25 microseconds to a maximum of 250 microseconds (at 25-microsecond increments).

The acquisition of voltage and current data can also be initiated relative to the acquisition trigger, thereby enabling the capture of pre-event and post-event data. To capture pre-event or post-event voltage and current data, the offset of data points relative to the trigger is programmed. The range of offset that can be programmed is from -4096 to  $2 \times 10^9$  points. If the offset is negative, the values at the beginning of the data buffer represent samples taken prior to the trigger. If the offset value is zero (the default setting), all data is acquired directly after the trigger. If the offset value is positive, the acquisition of valid buffer data will be delayed from the receipt of the trigger.

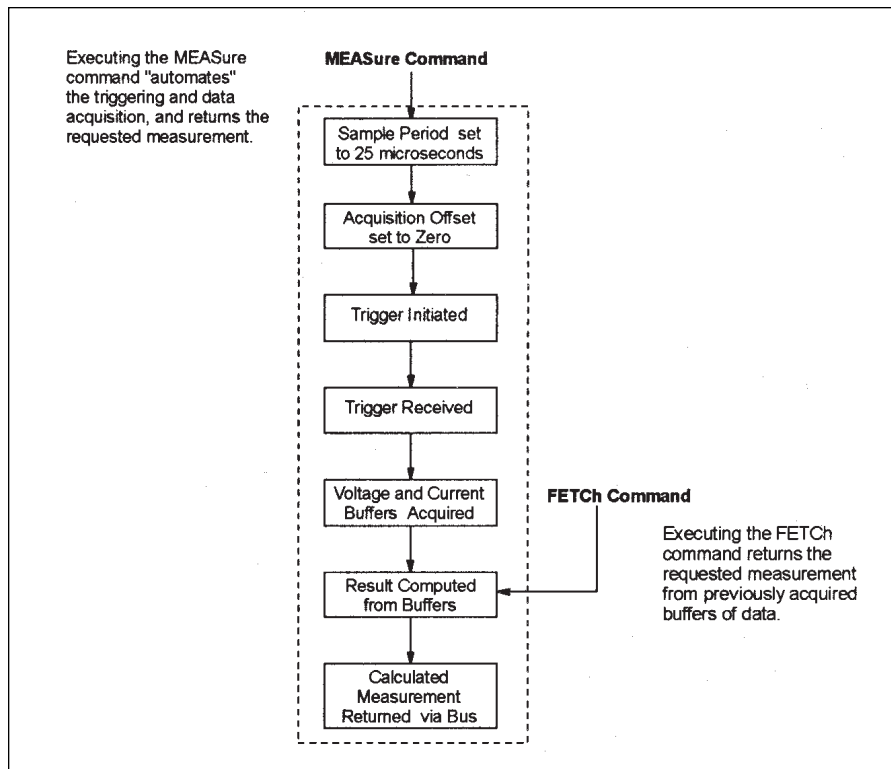

**MEASure and FETCh Command Execution Diagram**

# Applications

The following section contains six application examples. For each application, there is:

- An overview of the application
- A description of the Agilent 6800 series features used to implement the application
- The advantages and benefits of the 6800 series solution

- The details of the implementation of the solution
- A sample program in QBASIC using the National GPIB interface card
- A description of variations on the application (if applicable)

The following table lists the 6800 series features used in each of the applications.

	Application					
	1	2	3	4	5	6
<b>Transient Generation</b>						
Step mode				•		
Pulse mode	•					
List mode		•			•	
Transient generation with a trigger delay	•					
Synchronization with output phase	•			•		
User-defined waveform generation					•	
Voltage slew control	•					
Frequency slew control						
<b>Measurement and Analysis</b>						
Synchronization with transients						
Harmonic analysis			•			
Measurement window control			•			
High resolution current range measurements						•
Digitized data acquisition				•		
Event-referenced data acquisition				•		
Data acquisition sample rate control						•

# Application 1:

## Simulating AC Line Sub-Cycle Dropouts

### Overview of application

The ability of a switching power supply to maintain its output voltage setting in the presence of typical ac line disturbances is critical to its end-use. If the end-use of the power supply is installation into a computer, for example, sensitivity to ac line variations can result in unexpected loss of critical data and system downtime. To simulate these common ac line voltage variations, an amplitude controlled ac voltage can be applied to the ac input of the power supply.

For this example, the power supply requires a single phase ac source set to a nominal line voltage of 120 Vrms and frequency of 60 Hz. To test the power supply under worst case conditions, a voltage dropout to 0 Vrms should occur between 80° and 110° (i.e. a duration of 0.001389 seconds) on the voltage waveform. This is a steadystate test, which means that the dropout occurs after the ac input of the power supply under test has settled from all non-repetitive inrush conditions that typically occur at power-up.

### Agilent 6800 series features used

- RMS voltage in Pulse mode
- Trigger synchronization to the output voltage phase
- Trigger delay

### Advantages/benefits of the Agilent 6800 series solution

- By using the trigger phase synchronization capability, the timing of the dropout is accurate and repeatable.
- By using the transient capability, the computer is not devoted to sequencing the output.
- By using the trigger delay, it is assured that the power supply is in steadystate operation.
- One command initiates the test.

### Implementation details

#### How the 6800 series implements the dropout

The computer sends a trigger to the ac power source/analyzer with a programmable delay of 5 seconds to ensure that the ac input to the power supply under test is in a steadystate condition. The ac source outputs a low distortion 120 Vrms sine wave during the trigger delay and allows the power supply to stabilize into steadystate operation. After 5 seconds, the ac power source/analyzer responds to the trigger and drops the output voltage to 0 Vrms starting at 80° of one output voltage cycle and lasting for 0.001389 seconds.

#### Agilent 6800 series setup

- Connect the ac source output to the ac input of the power supply under test.
- Set the output waveform to sine.
- Set the rms voltage to Pulse mode.
- Set the initial (immediate) voltage to 120 Vrms.
- Set the triggered voltage level to 0 Vrms.
- Set the frequency to 60 Hz.
- Set the Pulse count to 1.
- Set the Pulse width to 0.001389 seconds (the width of 30° of phase dropout for a 60 Hz sine wave).
- Set the transient trigger source to BUS.
- Set the transient trigger source synchronization to PHASE.
- Set the phase synchronization to 80°.
- Set the trigger delay to 5 seconds.
- Initiate the transient trigger system.
- Enable the output of the ac power source/analyzer.
- Send a bus trigger.

Upon the receipt of the trigger, the ac source continues to output a 120 Vrms, 60 Hz sinewave for 5 seconds. After the 5-second trigger delay, the rms voltage drops to 0 Vrms at 80° of the cycle and then rises back to 120 Vrms (0.001389 seconds later) at 110° of the cycle.

**Variations on this implementation**

1. The Pulse width can be increased to simulate full cycle dropouts.
2. The Pulse count can be set to a value >1 and the Pulse period can be programmed to 0.01667 seconds (the period of a 60 Hz sinewave) to create multiple dropouts.
3. The triggered level of the rms voltage can be set higher than the initial setting of 120 Vrms to simulate a voltage surge.
4. The rms voltage slew rate can be programmed in Pulse mode to simulate a gradual brown out (sag) condition versus an abrupt dropout. The Pulse width can be increased to simulate a sag over multiple ac line cycles.

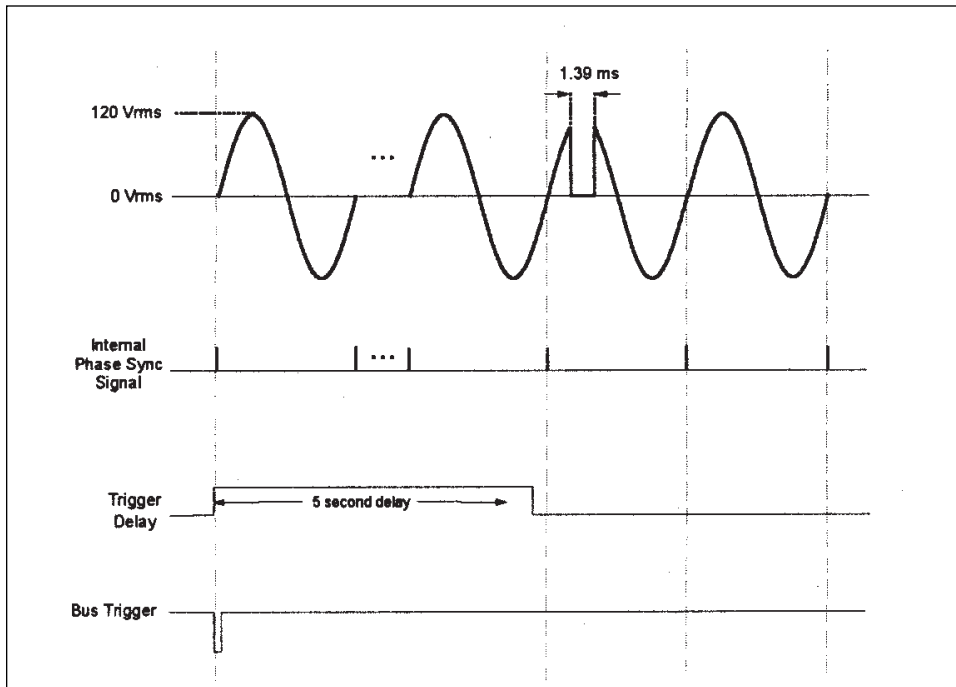

**Timing Diagram of Application 1**

```
'Program for Application 1
'Simulating AC Line Sub-cycle Dropouts
'Program: APP_1.BAS
```

```
DECLARE SUB ADDRESS ()
DECLARE SUB COMMAND (ADDR%, CMD$)
```

```
'Subroutine to open ac source communication
'Subroutine to send command strings
```

```
ACS% = 5
CALL ADDRESS
```

```
'Set AC source address variable to 5
'Open communication to address 5
```

```
CALL COMMAND(ACS%, "*RST")
CALL COMMAND(ACS%, "VOLT 120")
CALL COMMAND(ACS%, "CURRENT:PEAK MAX")
CALL COMMAND(ACS%, "VOLT:MODE PULSE")
CALL COMMAND(ACS%, "VOLT:TRIGGERED 0")
CALL COMMAND(ACS%, "PULSE:WIDTH 0.001389")
```

```
'Reset the ac source
'Set the immediate rms voltage to 120 Vrms
'Set the peak current limit to maximum
'Set the rms voltage to operate in Pulse mode
'Set the ac source to go to 0 Vrms on trigger
'Set the dropout duration
```

```
CALL COMMAND(ACS%, "TRIGGER:SYNCHRONIZE:SOURCE PHASE")
CALL COMMAND(ACS%, "TRIGGER:SYNCHRONIZE:PHASE 80")
CALL COMMAND(ACS%, "TRIGGER:SEQ1:SOURCE BUS")
CALL COMMAND(ACS%, "TRIGGER:DELAY 5")
CALL COMMAND(ACS%, "INITIATE:SEQ1")
```

```
'Trigger referenced to the output phase
'Set the trigger to occur at 80 degrees of phase
'Set the GPIB as the transient trigger source
'Delay the transient trigger for 5 seconds
'Initialize the transient trigger
```

```
CALL COMMAND(ACS%, "OUTPUT ON")
CALL COMMAND(ACS%, "*TRG")
END
```

```
'Turn on the ac source output
'Send the bus trigger
```

```
'Subroutines
```

```
SUB ADDRESS
OPEN "GPIBO" FOR OUTPUT AS #1
OPEN "GPIBI" FOR INPUT AS #2
PRINT #1, "ABORT"
PRINT #1, "GPIBEOS IN LF"
END SUB
```

```
SUB COMMAND (ADDR%, CMD$)
C$ = "OUTPUT " + STR$(ADDR%) + ";" + CMD$
PRINT #1, C$
END SUB
```

# Application 2: Generating MIL-STD-704D Waveforms

## Overview of application

U.S. Military Standard 704D (September 30, 1980) establishes the requirements of electrical power transfer between the aircraft or ground support electrical system, and the electronic equipment utilizing this power on board the aircraft. When testing to this standard, electrical aircraft equipment must be subjected to voltage and frequency transients that can occur under normal operation, emergency power operation, and during power source transfers.

The “pass” criteria for aircraft equipment is dependent upon the specification of the equipment under test. In general, the intent of the test is that:

- the equipment is permitted a degradation or loss of function unless required otherwise by its specifications
- the equipment is not permitted to produce a damaging or unsafe condition
- the equipment must automatically recover full specified performance when normal ac power characteristics are restored

For this example, the equipment under test has a single phase ac input with 115 Vrms and 400 Hz requirements. The device is tested under ac voltage transients initially, and then under frequency transient conditions. These transients are as follows:

*At 400 Hz:*

**Voltage Test 1:** 180 Vpk (127 Vrms) for 10 ms, and then slew to 124 Vpk (88 Vrms) at 800 Vpk (566 Vrms) per second.

**Voltage Test 2:** 80 Vpk (57 Vrms) for 10 ms, and then slew to 108 Vpk (76 Vrms) at 400 Vpk (283 Vrms) per second.

*At 115 Vrms:*

**Frequency Test 1:** 425 Hz for 1 s, 420 Hz for 4 s, 410 Hz for 5 s, and 407 Hz for 4 s.

**Frequency Test 2:** 375 Hz for 1 s, 380 Hz for 4 s, 390 Hz for 5 s, and 393 Hz for 4 s.

In this example, the voltage and frequency transients will be executed as an integrated test sequence.

## Agilent 6800 series features used

- RMS voltage and frequency control in List mode
- RMS voltage slew control
- List dwell time control
- Triggering system to execute the List

## Advantages/benefits of the Agilent 6800 series solution

- The List capability allows the ac power source/analyzer outputs to sequence through each RMS voltage and frequency setting with accurate timing according to the standard and without controller intervention.
- By using the programmable RMS voltage slew control, the RMS voltage level excursions can be faithfully reproduced as per the standard.
- The List settings for MIL-STD-704D are stored in non-volatile memory, so the test need only be set up once and then executed as needed.

## Implementation details

### How the 6800 series implements MIL-STD-704D RMS voltage and frequency transients

The computer sets up List sequence, then ac power source/analyzer is sent a bus trigger. Upon receipt of the trigger, the ac power source/analyzer’s output is set according to the voltage, voltage slew, and frequency values of the first List point. The output will remain at the first List point setting until the dwell time for that List point expires. The unit will then sequence through each successive List point paced by the respective dwell times until the List is completed. Upon completion of the List, the output will return to the immediate settings.

### Agilent 6800 series setup

- Connect the ac source output to the ac input of the equipment under test.
- Set the rms voltage to 115 Vrms.
- Set the frequency to 400 Hz.
- Set the rms voltage to List mode.
- Set the rms voltage slew to List mode.
- Set the frequency to List mode.
- Set the List to sequence automatically.

### Agilent 6800 series setup (continued)

- Set the List points as follows:

List Point	Vrms	frequency	Vrms Slew	Dwell Time
1	115 V	400 Hz	INF	*60 s
2	127 V	400 Hz	INF	0.01 s
3	88 V	400 Hz	566 V/s	0.07 s
4	115 V	400 Hz	INF	*60 s
5	57 V	400 Hz	INF	0.01 s
6	76 V	400 Hz	283 V/s	0.07 s
7	115 V	400 Hz	INF	*60 s
8	115 V	425 Hz	INF	1 s
9	115 V	420 Hz	INF	4 s
10	115 V	410 Hz	INF	5 s
11	115 V	407 Hz	INF	4 s
12	115 V	400 Hz	INF	*60 s
13	115 V	375 Hz	INF	1 s
14	115 V	380 Hz	INF	4 s
15	115 V	390 Hz	INF	5 s
16	115 V	393 Hz	INF	4 s
17	115 V	400 Hz	INF	*60 s

\* List points 1, 4, 7, 12, and 17 represent periods of time when the ac input to the equipment under test is set to the nominal levels prior to the onset of the next transient. The length of time the output of the ac power source/analyzer is set to the nominal level can be determined by user-convenience (60 seconds for this example).

- Set the transient trigger source to BUS.
- Initiate the transient trigger.
- Enable the output of the ac power source/analyzer.
- Send a bus trigger.

Upon receipt of the trigger, the List sequence will begin and the ac power source/analyzer output will go to the setting represented in the first List step. Each List step will be executed at the expiration of the programmed dwell time of the previous step. After the last List step is executed, the output of the ac source will change to the immediate output settings (Fixed mode settings).

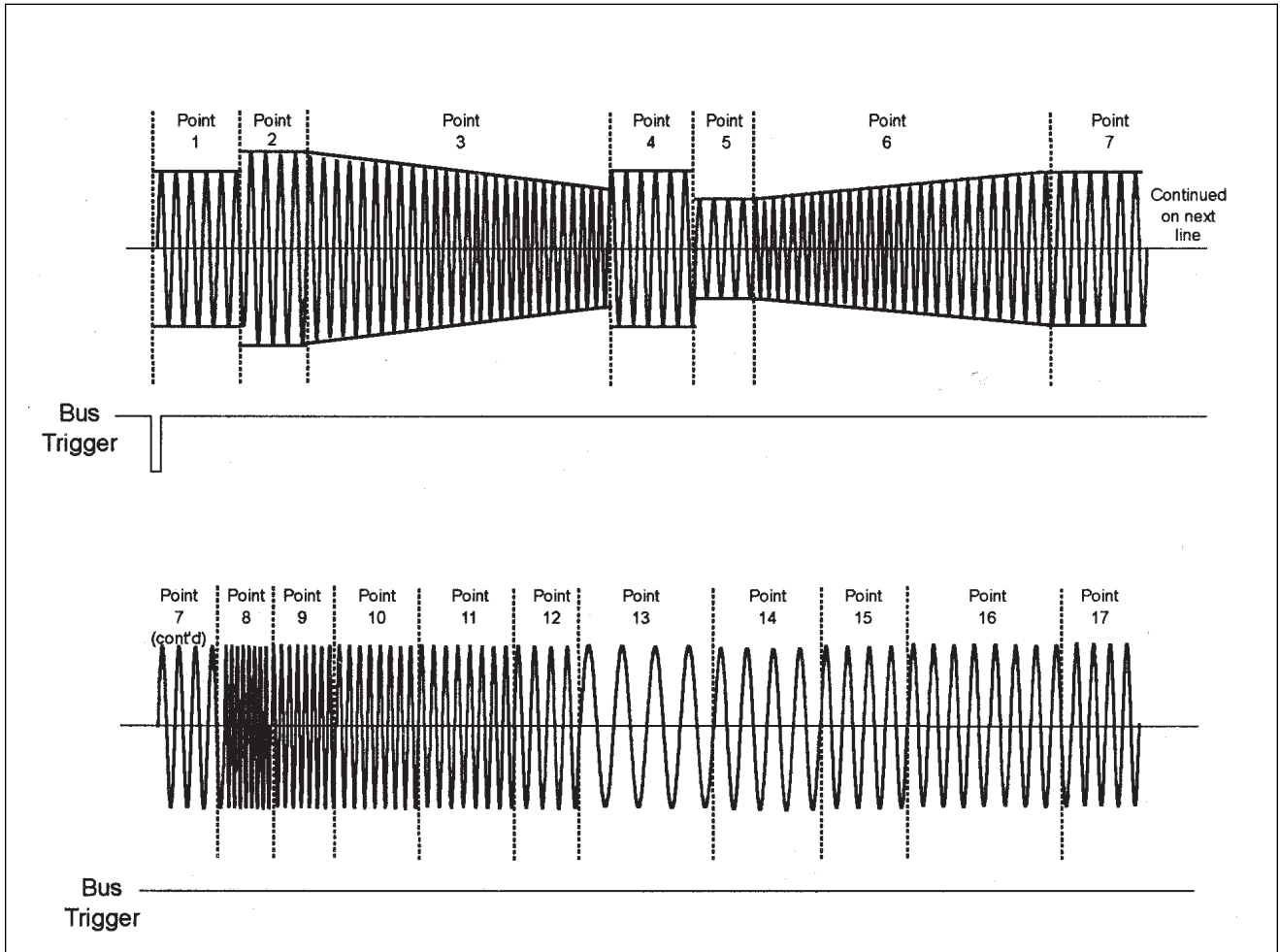

List Timing Diagram for Application 2



```
'Program for Application 2
'Generating MIL-STD-704D Waveforms
'Program: APP_2.BAS
```

```
DECLARE SUB ADDRESS () 'Subroutine to open ac source communication
DECLARE SUB COMMAND (ADDR%, CMD$) 'Subroutine to send command strings

ACS% = 5 'Set ac source address variable to 5
CALL ADDRESS 'Open communication to address 5

CALL COMMAND(ACS%, "*RST") 'Reset the ac source
CALL COMMAND(ACS%, "VOLT 115") 'Set the immediate voltage to 115 Vrms
CALL COMMAND(ACS%, "CURRENT:PEAK MAX") 'Set the peak current to maximum
CALL COMMAND(ACS%, "FREQUENCY 400") 'Set the immediate frequency to 400 Hz
CALL COMMAND(ACS%, "VOLT:MODE LIST") 'Set the rms voltage to operate in the List transient mode
CALL COMMAND(ACS%, "FREQ:MODE LIST") 'Set the frequency to operate in the List transient mode
CALL COMMAND(ACS%, "VOLT:SLEW:MODE LIST") 'Set the frequency slewing to operate in the List transient mode
CALL COMMAND(ACS%, "LIST:STEP AUTO") 'Set the List to be dwell time paced
```

```
'Set the rms voltage, frequency, frequency slew rate, and dwell time values
```

```
Vrms$ = "LIST:VOLT 115,127,88,115,57,76,115,115,115,115,115,115,115,115,115,115,115,115,115,115"
CALL COMMAND(ACS%, Vrms$)
Freq$ = "LIST:FREQ 400,400,400,400,400,400,400,425,420,410,407,400,375,380,390,393,400"
CALL COMMAND(ACS%, Freq$)
Vslew$ = "LIST:VOLT:SLEW MAX,MAX,566,MAX,MAX,283,MAX,MAX,MAX,MAX,MAX,MAX,MAX,MAX,MAX,MAX,MAX,MAX,MAX,MAX"
CALL COMMAND(ACS%, Vslew$)
Dwell$ = "LIST:DWELL 60,0.01,0.07,60,0.01,0.07,60,1,4,5,4,60,1,4,5,4,60"
CALL COMMAND(ACS%, Dwell$)
```

```
CALL COMMAND(ACS%, "TRIGGER:SOURCE BUS") 'Set the GPIB as the transient trigger source
CALL COMMAND(ACS%, "INITIATE:SEQ1") 'Initiate the transient trigger
CALL COMMAND(ACS%, "OUTPUT ON") 'Turn on the ac source output
CALL COMMAND(ACS%, "*TRG") 'Send the bus trigger
END
```

```
'Subroutines
```

```
SUB ADDRESS
OPEN "GPIB0" FOR OUTPUT AS #1
OPEN "GPIB0" FOR INPUT AS #2
PRINT #1, "ABORT"
PRINT #1, "GPIBEOS IN LF"
END SUB
```

```
SUB COMMAND (ADDR%, CMD$)
C$ = "OUTPUT " + STR$(ADDR%) + "," + CMD$
PRINT #1, C$
END SUB
```

# Application 3:

## Performing IEC 555-2 Measurements

### Overview of application

IEC 555-2 (1982) is a regulatory standard that pertains to ac line disturbances, namely current harmonics. These current harmonics are caused by connecting household appliances and similar electrical equipment to a 230 V, 50 Hz ac mains. This standard establishes limits on the amount of harmonic energy electrical equipment can inject on the ac line to ensure that other devices connected to the ac power distribution system are not adversely affected. The generated current harmonics can vary or fluctuate with time (due to electronic products that cycle the ac line), or can have steadystate (quasi-stationary) characteristics.

When testing electronic equipment with a single phase ac input for compliance to the quasi-stationary part of this standard, it is necessary to have an ac source with low distortion and low output impedance to avoid introducing unacceptable measurement errors. The measurement instrument must use the required Rectangular (or Hanning) measurement window and must have the capability to return measured current amplitude data up to the 40th harmonic of the fundamental.

### Agilent 6800 series features used

- RMS Voltage and frequency control
- Measurement window control
- Harmonic current measurement

### Advantages/benefits of the Agilent 6800 series

- The 6800 series provides a “One-Box” Solution, so a separate power analyzer is not required for quasi-stationary harmonic measurements.
- The 6800 series provides an IEC 555 compliant Rectangular measurement window built into the standard unit.
- The low distortion, low output impedance and 16-bit measurement accuracy of the 6800 series provide full compliance to the measurement requirements.

### Implementation details

#### How the 6800 series implements IEC 555 quasi-stationary harmonic current measurements

The output of the ac power source/analyzer is set to 230 V and 50 Hz. The measurement window is changed from the default value (KBessel) to the Rectangular window. To perform the harmonic analysis, the ac power source/analyzer is sent a command to measure an array of harmonic current amplitudes. This array of current harmonics can be transferred to the computer for PASS/FAIL analysis versus the limits of the standard.

### Agilent 6800 series setup

- The ac source output is connected to the ac input of the equipment under test.
- Set the output waveform to sine.
- Set the rms voltage to Fixed mode.
- Set the frequency to Fixed mode.
- Set the voltage to 230 Vrms.
- Set the frequency to 50 Hz.
- Set the measurement window to Rectangular.
- Enable the output of the ac power source/analyzer.
- Wait until the ac input to the equipment is in a steadystate condition.
- Send the harmonic current array measurement command to return 50 harmonic current amplitudes.

### Using the computer:

- Read the harmonic current array into the computer.
- Compare the measured harmonic current amplitudes of harmonic numbers 2 through 40 to the IEC 555-2 quasi-stationary standard limits.

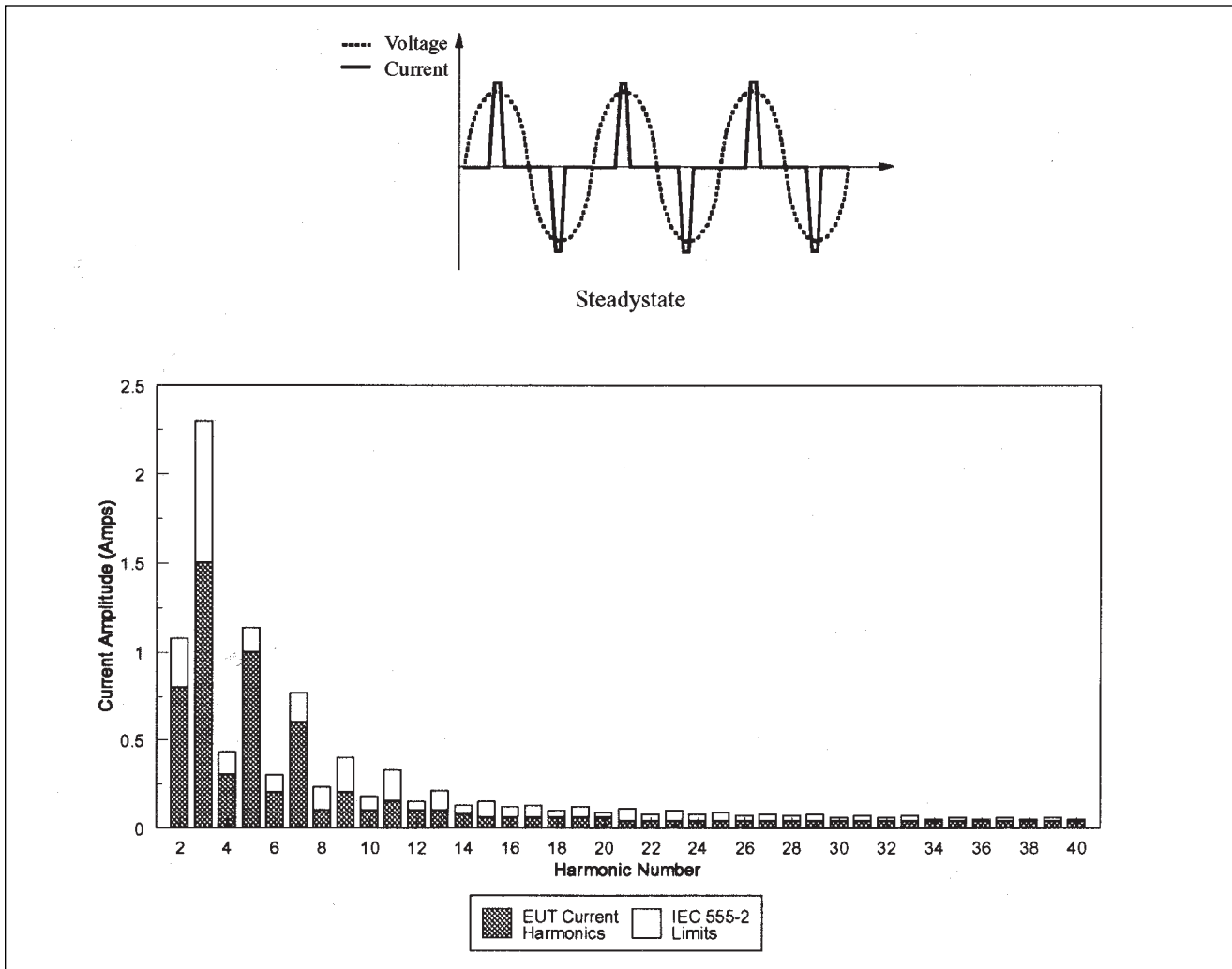

```
'Program for Application 3
'Performing IEC 555-2 Measurements
'Program: APP_3.BAS
```

```
DECLARE SUB ADDRESS ()
DECLARE SUB COMMAND (ADDR%, CMD$)
DECLARE SUB ENTER (ADDR%, RESULT$)
```

```
'Subroutine to open ac source communication
'Subroutine to send command strings
'Subroutine to return ac source measurements
```

```
IHARM$ = SPACE$(1500)
```

```
'Set maximum number of spaces for measurement
```

```
ACS% = 5
CALL ADDRESS
```

```
'Set ac source address to 5
'Open communication to address 5
```

```
CALL COMMAND(ACS%, "*RST")
CALL COMMAND(ACS%, "VOLT 230")
CALL COMMAND(ACS%, "CURRENT:PEAK MAX")
CALL COMMAND(ACS%, "FREQ 50")
CALL COMMAND(ACS%, "SENSE:WINDOW RECT")
CALL COMMAND(ACS%, "OUTPUT ON")
```

```
'Reset the ac source
'Set the immediate voltage to 230 Vrms
'Set the peak current limit to maximum
'Set the immediate frequency to 50 Hz
'Use a Rectangular measurement window as per the stan
'Turn on the ac source output
```

```
SLEEP 10
```

```
'Wait 10 seconds for a steadystate condition
```

```
CALL COMMAND(ACS%, "MEASURE:ARRAY:CURRENT:HARMONIC?")
CALL ENTER(ACS%, IHARM$)
```

```
'Measure the current harmonics
'Read the current harmonics
```

```
'Use the computer to compare the measured harmonics to IEC 555-2 limits
```

```
END
```

```
'Subroutines
```

```
SUB ADDRESS
OPEN "GPIB0" FOR OUTPUT AS #1
OPEN "GPIB0" FOR INPUT AS #2
PRINT #1, "ABORT"
PRINT #1, "GPIBEOS IN LF"
END SUB
```

```
SUB COMMAND (ADDR%, CMD$)
C$ = "OUTPUT " + STR$(ADDR%) + ";" + CMD$
PRINT #1, C$
END SUB
```

```
SUB ENTER (ADDR%, RESULT$)
PRINT #1, "enter " + STR$(ADDR%)
LINE INPUT #2, RESULT$
END SUB
```

## Application 4: Performing Inrush Current Measurements

### Overview of application

Switch mode power supplies are commonly used in many electronic products. These power supplies typically have input capacitors that cause high levels of peak inrush current to be drawn as they charge from the rectified line at turn-on. The peak amplitude of the inrush current varies with the turn-on phase of the ac voltage cycle. Usually, the highest peak inrush currents occur near the peak (90°) of the voltage cycle. Characterization of inrush current versus turn-on phase allows for determination of worst case inrush current conditions, which must be determined to properly select fuses and circuit breakers, to uncover component stresses, and to determine if a product will produce ac line disturbances that interact with other equipment connected to the branch circuit.

For this example, the equipment under test requires an ac line voltage of 120 Vrms at 60 Hz.

### Agilent 6800 series features used

- RMS voltage and frequency control
- Peak current measurement
- Pre-event current data capture
- Trigger synchronization to the output voltage phase
- Measurement and waveform generation synchronization
- High crest factor

### Advantages/benefits of the Agilent 6800 series solution

The 6800 series provides a “One-Box” Solution for measurement and waveform generation and eliminates the worry of synchronizing separate instruments. The ability to turn-on relative to the output voltage phase allows worst case inrush characterization, which results in a more reliable product.

### Implementation details

#### How the 6800 series implements peak inrush current measurements

The RMS voltage is programmed to Step mode to generate a turn-on condition from 0 Vrms to 120 Vrms. The turn-on is synchronized to the phase of the output voltage. The current measurement is programmed to occur at turn-on with 10 milliseconds of pre-event data to ensure that the full inrush event is captured. To characterize the inrush current of the unit under test, the turn-on phase is initially set to 40° for the first peak inrush current measurement and is then increased at 10° increments up to 90° for succeeding peak inrush current measurements. Between tests, the input capacitors of the unit under test are allowed to fully discharge for proper characterization.

### Agilent 6800 series setup

- Set the initial (immediate) voltage to 0 Vrms.
- Set the triggered voltage level to 120 Vrms.
- Set the frequency to 60 Hz.
- Set the peak current limit to maximum.
- Set the transient trigger source to BUS.
- Set the trigger synchronization source to Phase.
- Set the initial synchronization Phase to 40° (re-program to 50°, 60°, 70°, 80°, and 90°).
- Set the acquisition trigger source to TTLTrg.
- Set the data acquisition offset to -409 points.
- Enable the output of the ac power source/analyzer.
- Initiate the transient trigger.
- Initiate the acquisition trigger.
- Send a Bus trigger.
- Fetch the peak current measurement.

Upon receipt of the trigger, the ac power source/analyzer output goes to 120 Vrms when the phase voltage waveform reaches 40°. The data buffer acquires 409 instantaneous current data points before the turn-on event and 3687 instantaneous current data points beginning at the onset of the turn-on event (for a total buffer of 4096 current data points) to generate the peak current measurement. To continue the peak inrush current characterization, change the synchronization phase (from 40° to 50°, 60°, 70°, 80°, and 90°) and repeat the same procedure.

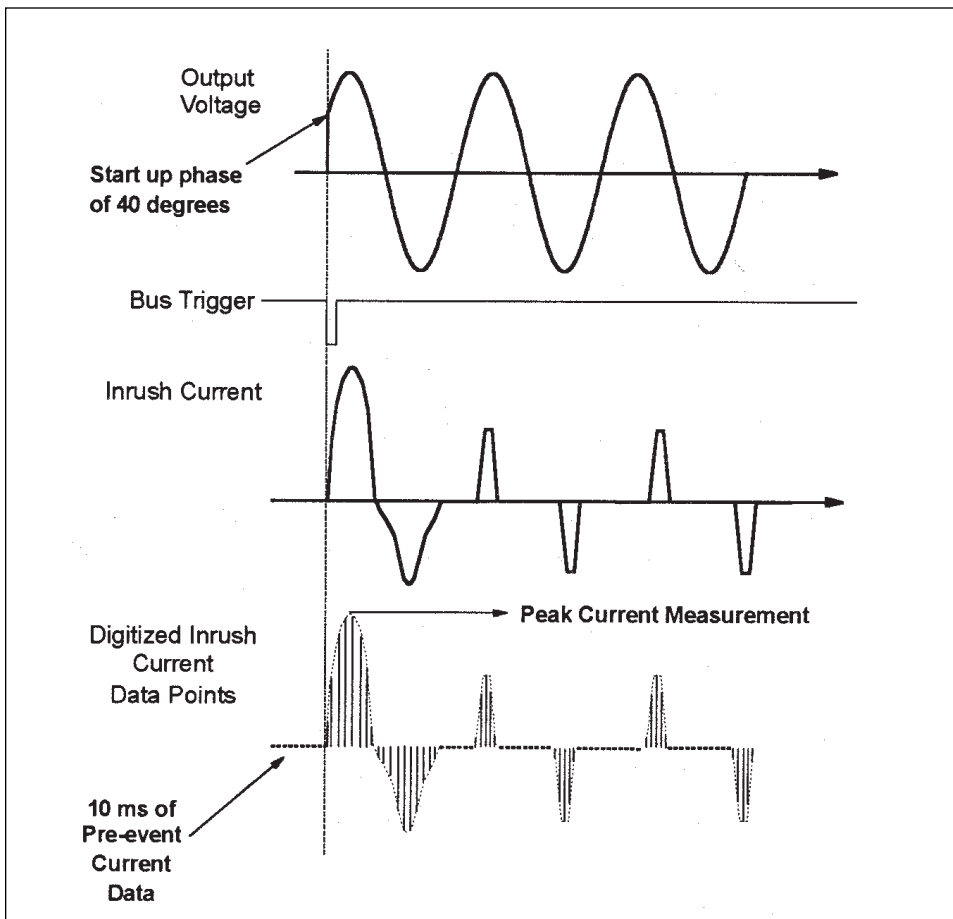

Timing Diagram for Application 4

'Program for Application 4  
 'Performing Inrush Current Measurements  
 'Program: APP\_4.BAS

'  
 DECLARE SUB ADDRESS ()  
 DECLARE SUB COMMAND (ADDR%, CMD\$)  
 DECLARE SUB ENTER (ADDR%, RESULT\$)  
 ACS% = 5  
 CALL ADDRESS

'Subroutine to open ac source communication  
 'Subroutine to send command strings  
 'Subroutine to read ac source measurements  
 'Set the ac source address to 5  
 'Open communication to address 5

'  
 CALL COMMAND(ACS%, "\*\*RST")  
 CALL COMMAND(ACS%, "VOLT 0")  
 CALL COMMAND(ACS%, "VOLT:MODE STEP")  
 CALL COMMAND(ACS%, "VOLT:TRIGGERED 120")  
 CALL COMMAND(ACS%, "CURRENT:PEAK MAX")  
 CALL COMMAND(ACS%, "OUTPUT ON")

'Reset the ac source  
 'Set the immediate voltage to 0 Vrms  
 'Set the rms voltage to operate in the Step transient mode  
 'Change the voltage to 120 Vrms on trigger  
 'Set the peak current to maximum  
 'Turn on the ac source output

'  
 CALL COMMAND(ACS%, "TRIGGER:SYNCHRONIZE:SOURCE PHASE")

'Set the trigger to occur referenced to the output phase

'  
 CALL COMMAND(ACS%, "TRIGGER:SYNCHRONIZE:PHASE 40")

'Set the trigger to occur at an output phase of 40 degrees.  
 'Increase this output phase to 90 degrees in 10 degree  
 'increments for full inrush current characterization.

'  
 CALL COMMAND(ACS%, "TRIGGER:SEQ1:SOURCE BUS")  
 CALL COMMAND(ACS%, "TRIGGER:SEQ3:SOURCE TTLT")  
 CALL COMMAND(ACS%, "OUTPUT:TTLT ON")

'Set the GPIB as the transient trigger source  
 'Set the measurement trigger source to the internal trigger  
 'Enable the internal trigger source

'  
 CALL COMMAND(ACS%, "SENSE:SWEEP:OFFSET:POINTS -409")  
 CALL COMMAND(ACS%, "INITIATE:SEQ1")  
 CALL COMMAND(ACS%, "INITIATE:SEQ3")  
 CALL COMMAND(ACS%, "\*\*TRG")  
 CALL COMMAND(ACS%, "FETCH:CURRENT:AMPLITUDE:MAX?")

'Capture 409 samples of pre-trigger data  
 'Initiate the transient trigger  
 'Initiate the measurement trigger  
 'Send the bus trigger  
 'Make a peak current measurement from acquired data

'  
 CALL ENTER(ACS%, IPEAK\$)  
 CALL COMMAND(ACS%, "OUTPUT OFF")  
 PRINT IPEAK\$  
 END

'Read the peak current measurement  
 'Turn off the ac source output  
 'Print the peak current measurement

'Subroutines

'  
 SUB ADDRESS  
 OPEN "GPIB0" FOR OUTPUT AS #1  
 OPEN "GPIB0" FOR INPUT AS #2  
 PRINT #1, "ABORT"  
 PRINT #1, "GPIBEOS IN LF"  
 END SUB

'  
 SUB COMMAND (ADDR%, CMD\$)  
 C\$ = "OUTPUT " + STR\$(ADDR%) + ";" + CMD\$  
 PRINT #1, C\$  
 END SUB

'  
 SUB ENTER (ADDR%, RESULT\$)  
 PRINT #1, "enter " + STR\$(ADDR%)  
 LINE INPUT #2, RESULT\$  
 END SUB

# Application 5: Generating User-Defined Waveforms

## Overview of application

The creation of user-defined waveforms is useful for simulating ac line disturbances that are unique to the operational environment of the device being tested, and then measuring that device's susceptibility to the disturbance. This is the fundamental objective of environmental test standards that pertain to the ac line. A specific example is the draft for IEC 77A (Secretariat) 101 draft (dated 10/15/93), which defines the test and measurement methods for evaluating electronic and electrical equipment immunity to voltage harmonics and inter-harmonics on the ac line. Upon subjecting the equipment to the voltage harmonics, it must recover to its full operative capabilities to meet the "pass" criteria of this draft.

For this example, a waveform with harmonic voltage content as defined by the IEC 77A (Secretariat) 101 draft (dated 10/15/93) will be created, stored, and generated by the ac power source/analyzer.

Harmonic Number	Harmonic Voltage Levels (for 120 Vrms)	
	Class 1	Class 2
3	9.6 V	7.2 V
5	10.8 V	9.6 V
7	6 V	8.4 V
11	2.4 V	8.4 V
13	2.4 V	7.2 V

The equipment under test used for this example has an ac input rating of 120 Vrms, 60 Hz, and 5 Arms. The waveform generated will comply with the Class 1 harmonic combination (as currently proposed) shown above. This draft specifies that the equipment under test must be subjected to the harmonic waveform of either Class for 2 minutes, succeeded by 2 minutes of the fundamental (120 Vrms sinewave) waveform.

## Agilent 6800 series features used

- Non-volatile, user-defined (arbitrary) waveform creation/storage
- rms voltage programming
- Frequency programming
- Waveform shape transient generation
- List transient mode

## Advantages/benefits of the Agilent 6800 series solution

The user-defined waveform is stored in non-volatile memory, eliminating the need for constant re-creation and making it easy to recall the waveform as the test is needed. A List of output waveforms can be generated by combining built-in and user-defined waveforms, simplifying complex test sequences. The user-defined waveform can be recalled as if it was one of the standard output shapes (such as sine and square waveforms) and can be used in all modes where the FUNCTION:SHAPE command is valid.

## Implementation details

### How the 6800 series implements user-defined waveforms

The computer is used to generate an array of 1024 voltage amplitude points that represent one cycle of the 77A (Secretariat) 101 Class 1 waveform. This data is sent to the ac source as a named (CLASS 1) user-defined waveform and is stored in a non-volatile memory location. The List mode of the ac power source/analyzer is used to sequence through the appropriate output settings at 2-minute intervals as per the draft. The programmed parameters for each List point are shape (waveform) and dwell time. The rms voltage and frequency output settings remain in Fixed mode. The first List point is the fundamental waveform (120 Vrms sinewave at 60 Hz) and will be output upon receipt of a transient trigger for 2 minutes. The CLASS 1 waveform will be output for 2 minutes as part of the second List point. After this 2-minute test, the fundamental waveform will be output again as part of the final List point.



**Agilent 6800 series setup**

- Connect the ac source output to the ac input of the equipment under test.
- Use the computer to develop a 1024 point array representing a cycle of voltage amplitude data.
- Use the TRACe:DEFine command to name the waveform CLASS 1 and allocate non-volatile storage space.
- Use the TRACe:DATA command to send the 1024 point array to the ac power source/analyzer.
- Set the Shape to List mode.
- Set the List points as follows:

List Point	Shape	Dwell Time
1	Sine	120 s
2	CLASS1	120 s
3	Sine	120 s

- Set the List to sequence automatically.
- Set the transient trigger source to BUS.
- Initiate the transient trigger.
- Enable the output.
- Send a Bus trigger.

Upon receipt of the trigger, the first List step is executed and the output is set to a 120 Vrms, 60 Hz sinewave. After 120 seconds, the ac power source/analyzer automatically executes the second List step. The output will remain at the CLASS 1 test level for 120 seconds and then will execute the third List step. After the entire List is executed, the output of the ac power source/analyzer will return to the Fixed mode levels.

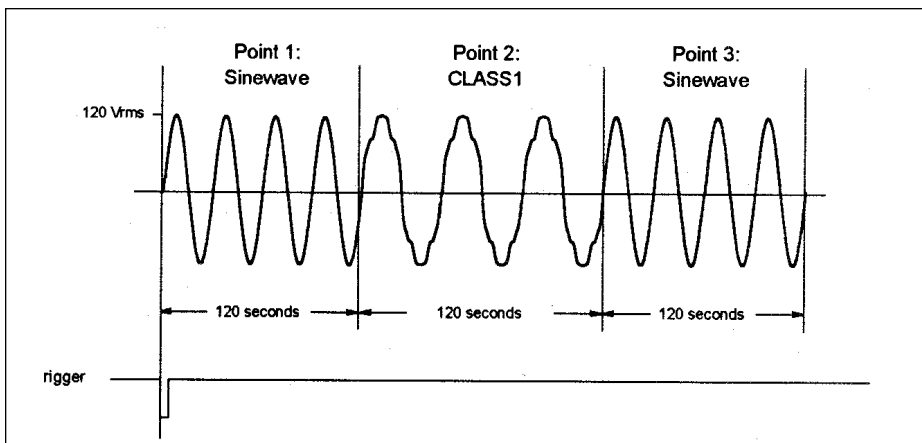
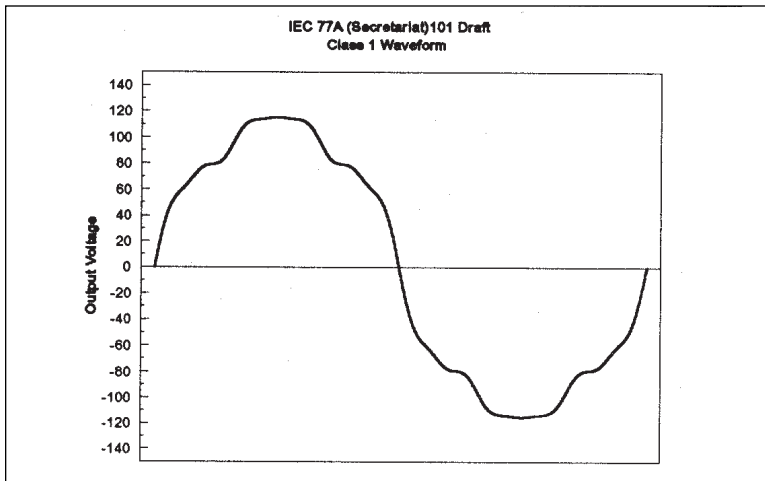

**Timing Diagram for Application #5**

```

Program for Application 5
'Generating User-defined Waveforms
Program: APP_5.BAS
,
DECLARE SUB COMMANDNOCRLF (ADDR%, CMD$, LENGTH!) 'Subroutine to send command strings without a CRLF
DECLARE SUB ADDRESS () 'Subroutine to send a command string
DECLARE SUB COMMAND (ADDR%, CMD$) 'Subroutine to send command strings
,
ACS% = 5 'Set ac source address variable to 5
CALL ADDRESS 'Open communication to address 5
,
'Set the variables
,
OPTION BASE 0
DIM Wfdata!(1024)
DIM WFSTR$(5000)
Shapename$ = "CLASS1"
PI = 3.141593
Frequency = 60
,
'Set harmonic number and amplitudes for Class 1 waveform
,
Comps:
    DATA 1,120
    DATA 3,9.6
    DATA 5,10.8
    DATA 7,6
    DATA 11,2.4
    DATA 13,2.4
    DATA 0,0
,
'Ensure array is dimensioned properly
,
FOR I = 0 TO 1023
    Wfdata!(I) = 0
NEXT I
,
'Create the Class 1 waveform
,
RESTORE Comps
HARMLOOP:
READ Harm
READ Ampl
IF Harm = 0 THEN GOTO Download
FOR I = 0 TO 1023
    Wfdata!(I) = Wfdata!(I) + Ampl * SIN(2 * PI * Harm * I / 1024)
NEXT I
GOTO HARMLOOP
,
Name the waveform CLASS1, and download to the ac source
,
Download:
CALL COMMAND(ACS%, "TRACE:DEFINE " + LTRIM$(Shapename$))
WFSTR$ = "TRACE:DATA " + LTRIM$(Shapename$)
CALL COMMANDNOCRLF(ACS%, WFSTR$, LEN(WFSTR$))
FOR I = 0 TO 1022
    WFSTR$ = " " + LTRIM$(STR$(Wfdata!(I)))
    CALL COMMANDNOCRLF(ACS%, WFSTR$, LEN(WFSTR$))
NEXT I
WFSTR$ = " " + LTRIM$(STR$(Wfdata!(1023)))
CALL COMMAND(ACS%, WFSTR$)
,
'Create the List transient to test to the standard
,

```

Lists:

```
CALL COMMAND(ACS%, "VOLT:MODE LIST") 'Set the rms voltage to operate in the List transient mode
CALL COMMAND(ACS%, "FREQ:MODE LIST") 'Set the frequency to operate in the List transient mode
CALL COMMAND(ACS%, "FUNC:SHAPE:MODE LIST") 'Set the waveshape to operate in List transient mode
CALL COMMAND(ACS%, "LIST:VOLTAGE 120,120,120") 'Set the rms voltage List points
CALL COMMAND(ACS%, "LIST:FREQUENCY 60,60,60") 'Set the frequency list points
CALL COMMAND(ACS%, "LIST:SHAPE SIN,CLASS1,SIN") 'Set the waveshape List points
CALL COMMAND(ACS%, "LIST:DWELL 120,120,120") 'Set the List point dwell times
CALL COMMAND(ACS%, "LIST:STEP:AUTO") 'Set the List to be dwell time paced
,
CALL COMMAND(ACS%, "OUTPUT ON") 'Turn on the ac source output
CALL COMMAND(ACS%, "TRIGGER:SEQ1:SOURCE BUS") 'Set the GPIB as the transient trigger source
CALL COMMAND(ACS%, "INITIATE:SEQ1") 'Initiate the transient trigger
CALL COMMAND(ACS%, "*TRG") 'Send the bus trigger
END
,
'Subroutines
,
SUB ADDRESS
OPEN "GPIB0" FOR OUTPUT AS #1
OPEN "GPIB0" FOR INPUT AS #2
PRINT #1, "ABORT"
PRINT #1, "GPIBEOS IN LF"
END SUB

SUB COMMAND (ADDR%, CMD$)
C$ = "OUTPUT " + STR$(ADDR%) + ";" + CMD$
PRINT #1, C$
END SUB

SUB COMMANDNOCRLF (ADDR%, CMD$, LENGTH!)
C$ = "OUTPUT " + STR$(ADDR%) + "#" + STR$(LENGTH!) + "NOEND" + ";" + CMD$
PRINT #1, C$
END SUB
```

# Application 6:

## Operating the Agilent 6812A and 6813A at Low Frequencies

### Overview of application

For some applications, such as the simulation of European railway power systems, a low frequency (16.6 Hz) ac waveform is required. Generating low frequency waveforms with ac sources can present testing challenges due to output power derating and programming inaccuracies, depending on the regulation technique used. If the ac source has measurement capability, control of the measurement sample period is necessary to capture sufficient cycles of the output waveform to ensure measurement accuracy.

The 6812A and 6813A can meet the above challenges at frequencies below 45 Hz. These two models provide precise control of the waveform generation and measurement system for optimal operation at low frequencies. For this example, the equipment under test will require an ac input at 230 Vrms and 16.6 Hz. Real power, apparent power, and power factor will be accurately measured using the high resolution current measurement range.

### Agilent 6812A and 6813A features used

- Programmable Vrms and frequency
- Realtime regulation mode
- Sinewave generation
- Programmable voltage and current sample rate
- Power measurement (power factor, VA, and Watts)
- x10 current measurement range

### Advantages/benefits of the Agilent 6812A and 6813A solutions

- Programmable regulation mode allows for accurate output voltage and current limit control.
- Programmable measurement sample rate provides high accuracy measurements for low frequency signals.
- Use of the FETCh command provides fast measurements from the same data buffers.
- x10 current measurement range increases the accuracy for low current and low power measurements.

### Implementation details

#### How the 6812A and 6813A generate low frequency ac waveforms and perform low frequency ac measurements

A 230 Vrms sinewave is programmed at a frequency of 16.6 Hz. To perform measurements at this output frequency, the programmable sample period is increased from 25 microseconds to 75 microseconds. A triggered acquisition of voltage and current provide the data from which the power measurements are calculated. This method of acquisition is necessary since the MEASure command will reset the sample period back to the default value of 25 microseconds. A FETCh command is sent to return the real power (Watts), power factor, and apparent power measurements from the same voltage and current data buffer.

#### Agilent 6800 series setup

- Connect the ac source output to the ac input of the equipment under test.
- Set the regulation mode to Realtime.
- Set the rms voltage to Fixed mode.
- Set the frequency to Fixed mode.
- Set the shape to sine.
- Set the rms voltage to 230 V.
- Set the frequency to 16.6 Hz.
- Enable the output.
- Set the measurement sample period to 75 microseconds.
- Trigger the acquisition of voltage and current data.
- Fetch the real power.
- Fetch the power factor.
- Fetch the apparent power.

```

Program for Application 6
'Operating the 6812A and 6813A at Low frequencies
Program: APP_6.BAS

```

```

DECLARE SUB ADDRESS ()
DECLARE SUB COMMAND (ADDR%, CMD$)
DECLARE SUB ENTER (ADDR%, RESULT$)

```

```

'Subroutine to open ac source communication
'Subroutine to send command strings
'Subroutine to return ac source measurements

```

```

ACS% = 5
CALL ADDRESS

```

```

'Set ac source variable address to 5
'Open communication to address 5

```

```

VARdg$ = SPACES$(50)
WRdg$ = SPACES$(50)
PFRdg$ = SPACES$(50)

```

```

'Set number of spaces in VA measurement string
'Set number of spaces in Watts measurement string
'Set number of spaces in Power Factor measurement string

```

```

CALL COMMAND(ACS%, "**RST")
CALL COMMAND(ACS%, "VOLT 230")
CALL COMMAND(ACS%, "FREQ 16.6")
CALL COMMAND(ACS%, "OUTPUT ON")

```

```

'Reset the ac source
'Set the immediate voltage to 230 Vrms
'Set the immediate frequency to 16.6 Hz
'Turn on the ac source output

```

```

CALL COMMAND(ACS%, "SENSE:CURRENT:ACDC:RANGE MIN")
CALL COMMAND(ACS%, "SENSE:SWEEP:TINTERVAL 75E-6")

```

```

'Use the high resolution current measurement range
'Set the sample period to 75 microseconds

```

```

CALL COMMAND(ACS%, "TRIGGER:SEQ3:SOURCE BUS")
CALL COMMAND(ACS%, "INITIATE:SEQ3")
CALL COMMAND(ACS%, "**TRG")

```

```

'Set the GPIB as the measurement trigger source
'Initiate the measurement trigger

```

```

Measure, read, and print the VA, Watts, and power factor measurements

```

```

CALL COMMAND(ACS%, "FETCH:POWER:AC:APPARENT?")
CALL ENTER(ACS%, VARdg$)
CALL COMMAND(ACS%, "FETCH:POWER:AC?")
CALL ENTER(ACS%, WRdg$)
CALL COMMAND(ACS%, "FETCH:POWER:AC:PFACTOR?")
CALL ENTER(ACS%, PFRdg$) PRINT VARdg$, WRdg$, PFRdg$
END

```

```

'Subroutines

```

```

SUB ADDRESS
OPEN "GPIB0" FOR OUTPUT AS #1
OPEN "GPIB0" FOR INPUT AS #2
PRINT #1, "ABORT"
PRINT #1, "GPIBEOS IN LF"
END SUB

```

```

SUB COMMAND (ADDR%, CMD$)
C$ = "OUTPUT " + STR$(ADDR%) + "," + CMD$
PRINT #1, C$
END SUB

```

```

SUB ENTER (ADDR%, RESULT$)
PRINT #1, "enter " + STR$(ADDR%)
LINE INPUT #2, RESULT$
END SUB

```

**Agilent Technologies' Test and Measurement Support, Services, and Assistance**

Agilent Technologies aims to maximize the value you receive, while minimizing your risk and problems. We strive to ensure that you get the test and measurement capabilities you paid for and obtain the support you need. Our extensive support resources and services can help you choose the right Agilent products for your applications and apply them successfully. Every instrument and system we sell has a global warranty. Support is available for at least five years beyond the production life of the product. Two concepts underlie Agilent's overall support policy: "Our Promise" and "Your Advantage."

**Our Promise**

"Our Promise" means your Agilent test and measurement equipment will meet its advertised performance and functionality. When you are choosing new equipment, we will help you with product information, including realistic performance specifications and practical recommendations from experienced test engineers. When you use Agilent equipment, we can verify that it works properly, help with product operation, and provide basic measurement assistance for the use of specified capabilities, at no extra cost upon request. Many self-help tools are available.

**Your Advantage**

"Your Advantage" means that Agilent offers a wide range of additional expert test and measurement services, which you can purchase according to your unique technical and business needs. Solve problems efficiently and gain a competitive edge by contracting with us for calibration, extra-cost upgrades, out-of-warranty repairs, and on-site education and training, as well as design, system integration, project management, and other professional services. Experienced Agilent engineers and technicians worldwide can help you maximize your productivity, optimize the return on investment of your Agilent instruments and systems, and obtain dependable measurement accuracy for the life of those products.

By internet, phone, or fax, get assistance with all your test and measurement needs.

**Online Assistance**

[www.agilent.com/find/assist](http://www.agilent.com/find/assist)

**Phone or Fax**

United States:

(tel) 1 800 452 4844

Canada:

(tel) 1 877 894 4414

(fax) (905) 206 4120

Europe:

(tel) (31 20) 547 2323

(fax) (31 20) 547 2390

Japan:

(tel) (81) 426 56 7832

(fax) (81) 426 56 7840

Latin America:

(tel) (305) 269 7500

(fax) (305) 269 7599

Australia:

(tel) 1 800 629 485

(fax) (61 3) 9210 5947

New Zealand:

(tel) 0 800 738 378

(fax) (64 4) 495 8950

Asia Pacific:

(tel) (852) 3197 7777

(fax) (852) 2506 9284

Product specifications and descriptions in this document subject to change without notice.

Copyright © 1995, 2000 Agilent Technologies  
Printed in U.S.A. 10/00  
5963-7044E



**Agilent Technologies**

Innovating the HP Way